

Date	Number	Form Cod

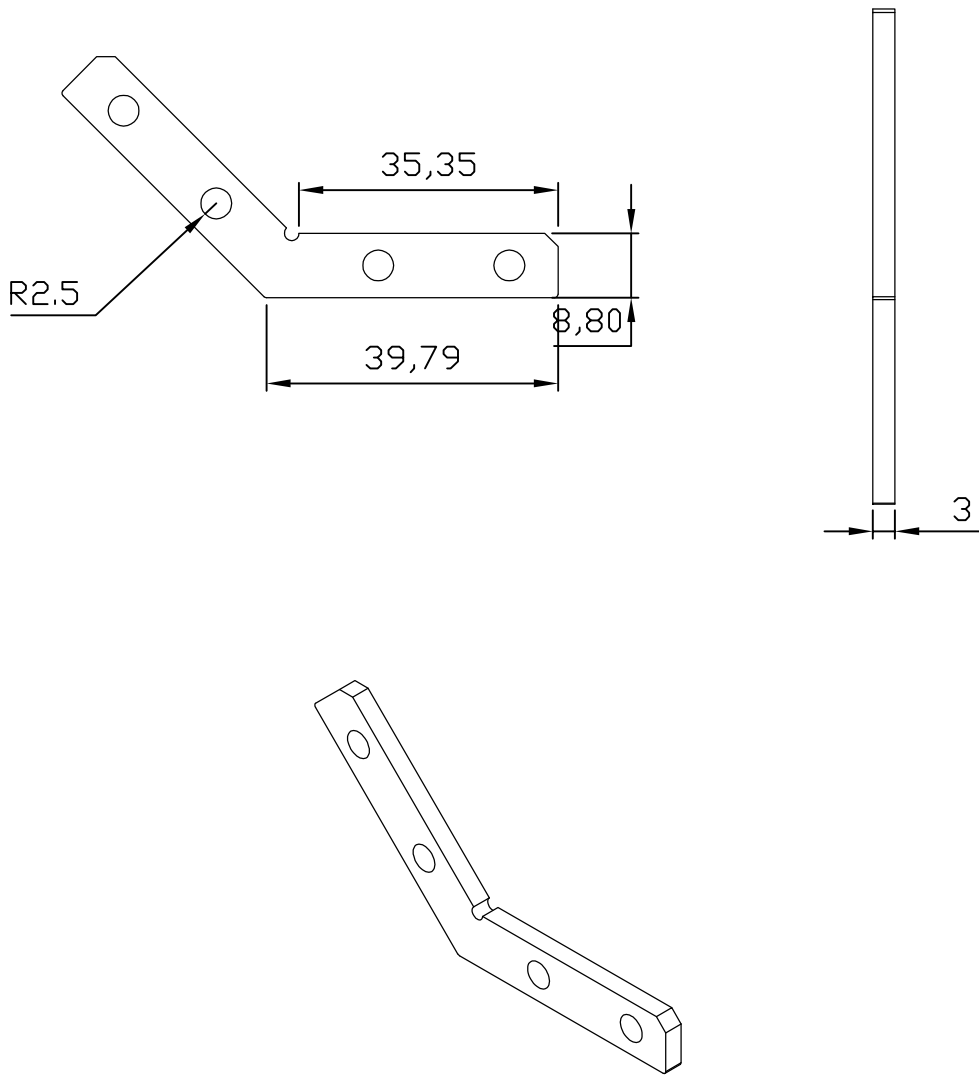

REV	DESCRIPTION					DATE	APVD
	Designed by	Checked by	Approved by - date	Edition	Date	VYMAND	
	Eslami Fard			1	96/09/28		
HIDDEN-CORNER-135-SLOT6			Material	dimension	Scale	STD: ISO	
			Steel	MM	1:1		
Qty:	Weight:	Tol:	DRAWING_NUMBER:				
			HIDDEN-CORNER-135-SLOT6				